

Stilt

technical specification



.mdd

.mdd has a leading position among manufacturers of office furniture with many awards that prove quality and continuously increase demand for it's products.

The realities of today`s market require constant quality improvement at all levels of modern organization. This applies in particular to customer service, marketing, quality of products and also to quality of processes within the company.

Partnership relations among employees and with business partners form a base of economic growth and success of the company.

Constant investments in innovative machinery park, optimization of management systems and an expansion of production halls allow to minimize the lead times for the product of the highest quality.

More than twenty years of experience in office furniture industry come with reference from a long list of companies and institutions to show their appreciation for an efficient and comprehensive service. .mdd is highly aware of the environment.

Being located in the forest region with lake by it's side, .mdd takes the nature seriously and invests constantly in a modern and energy-efficient solutions to preserve the local life. Company puts emphasis on waste segregation and recycling. .mdd has been awarded for the exceptional care and involvement in waste disposal. All materials used are environmentally friendly and enjoy a high 95 % rate of being recycled.



General informations:

Warranty:

.mdd products - **5 years.**

Electrical components and fabric - **2 years.**

Certificate - MFC:



Certificate - fabric:



Assembly:

the product comes pre-assembled

Packing:

foam wrap, cardboard

<p>Stilt</p>	<p>Date of preparation 07.02.2022</p>	<p>The data contained in this document is valid in the day of its preparation. Change of the product, as long as it does not affect the basic features of it, does not require consistent updates of the document.</p>	<p>page 2/13 general informations</p>
--------------	-------------------------------------------	------------------------------------------------------------------------------------------------------------------------------------------------------------------------------------------------------------------------	--------------------------------------------------

Stilt - armchair, sofa

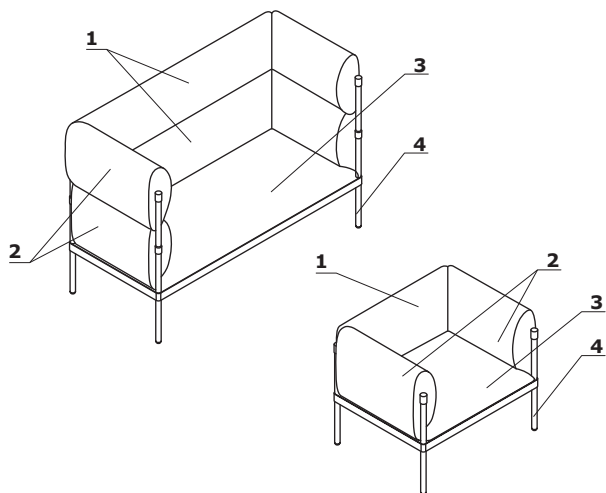

1. **Backrest** - 18 mm thick particle board framework; cut foam, density of 25 kg/m³; upholstered
2. **Armrests** - 18 mm thick particle board framework; cut foam, density of 40 kg/m³; upholstered
3. **Seat** - steel framework with springs; cut foam, density of 35 kg/m³; upholstered
4. **Base** - 4-legged, powder coated steel; legs made of tube Ø 30 mm, wall thickness 2 mm

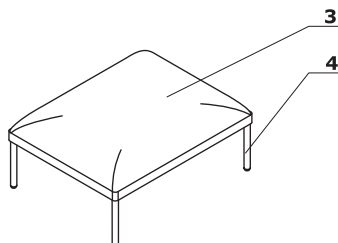

Accessories - armchair, sofa

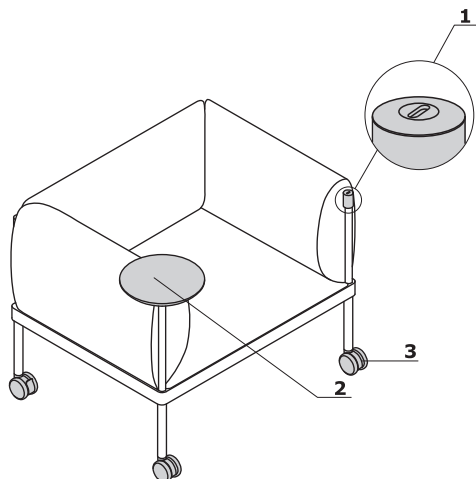

OPTIONS WITH EXTRA CHARGE:

1. **Mediabox M010** - USB A, C; 5V, 2x2,5 Amp
2. **Worktop** - MDF lacquered 19 mm - in frame colour; powder coated steel
3. **Castors** - with brakes; Ø75 mm

Stilt - shelving unit

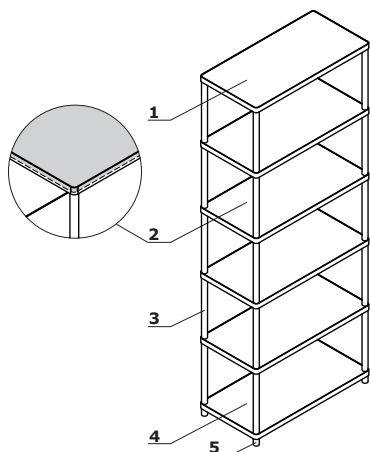

1. **Top** - 19 mm thick varnished MDF board with metal frame (3x30 mm)
2. **Shelf** - 19 mm thick varnished MDF board with metal frame (3x30 mm)
3. **Profile** - powder coated steel, Ø30 mm, wall thickness 2 mm
4. **Base** - 19 mm thick varnished MDF board with metal frame (3x30 mm)
5. **Leveling feet** - height 14mm, made from polythene, colour: black or grey

Dimensions - armchair, sofa

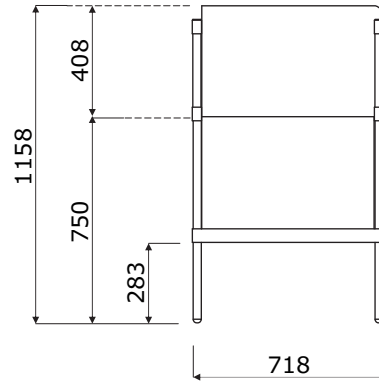
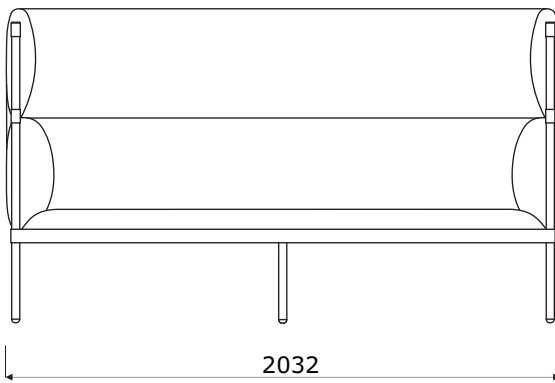
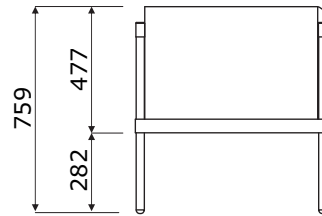
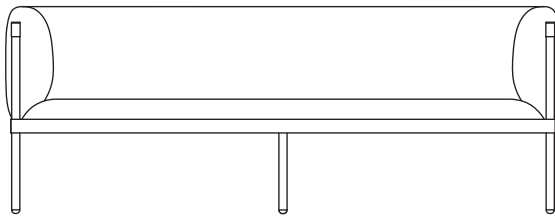
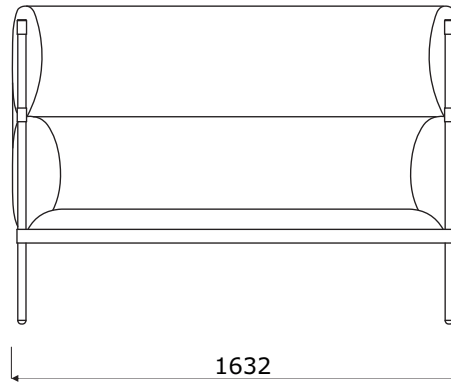
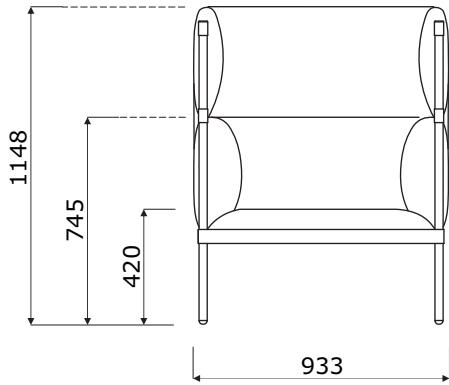
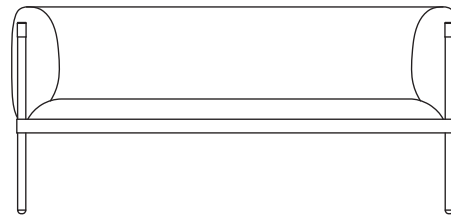
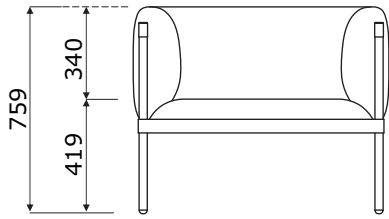

Dimensions - stool

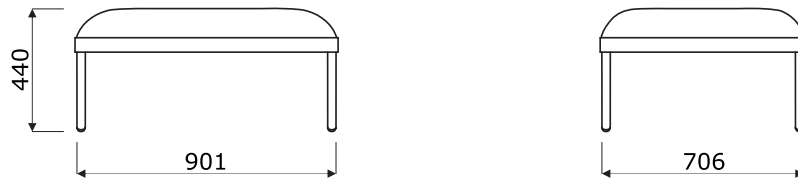

Stilt	Date of preparation 07.02.2022	The data contained in this document is valid in the day of its preparation. Change of the product, as long as it does not affect the basic features of it, does not require consistent updates of the document.	page 5/13
			dimensions (mm)

Dimensions - shelving unit

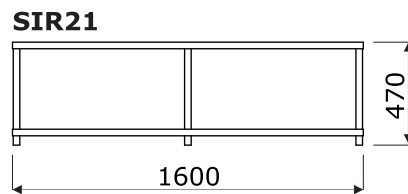
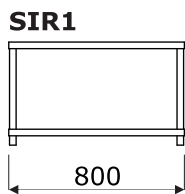
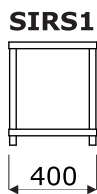
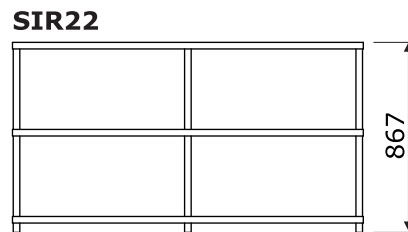
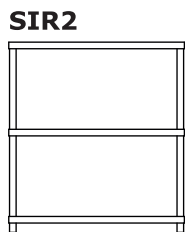
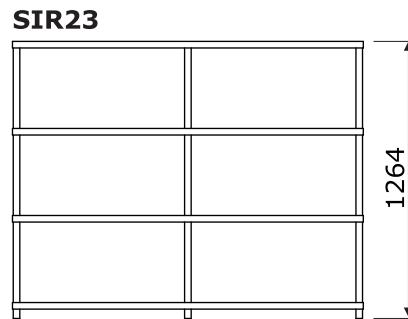
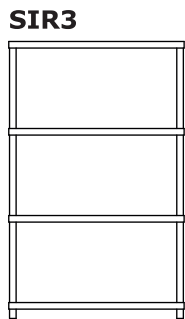
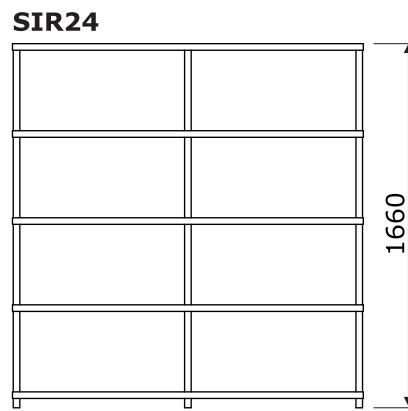
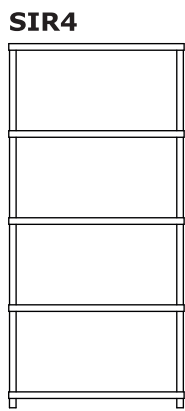
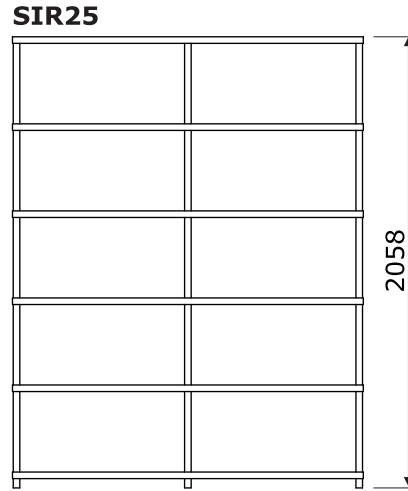
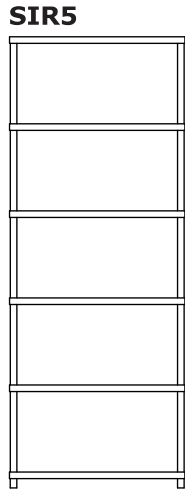

Stilt - armchair, sofa *

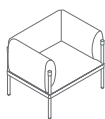

SIS1
932 / 718 / 758
36 kg

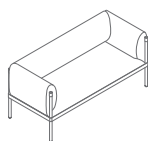

SIS2
1632 / 718 / 758
51.3 kg

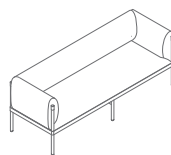

SIS3
2032 / 718 / 758
61.5 kg

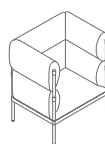

SISH1
932 / 718 / 1158
51.9 kg

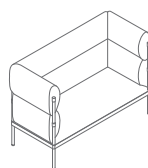

SISH2
1632 / 718 / 1158
72.1 kg

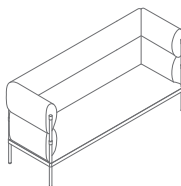

SISH3
2032 / 718 / 1158
55 kg

Stilt - stool *

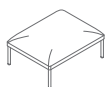

SIS4
901 / 706 / 441
36 kg

* dimensions expressed in millimeters: width x depth x height

Stilt	Date of preparation 07.02.2022	The data contained in this document is valid in the day of its preparation. Change of the product, as long as it does not affect the basic features of it, does not require consistent updates of the document.	page 7/13
			products

Stilt - bookcase *



SIRS1
400 / 400 / 470
10.9kg



SIR1
800 / 400 / 470
17.4 kg

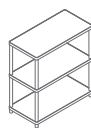

SIR2
800 / 400 / 867
26.6 kg



SIR3
800 / 400 / 1264
36.7 kg

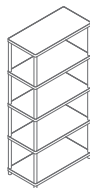

SIR4
800 / 400 / 1660
46 kg

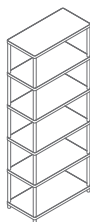

SIR5
800 / 400 / 2058
55.2 kg

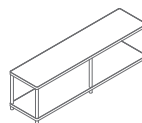

SIR21
1600 / 400 / 470
31 kg

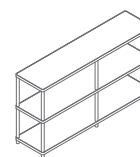

SIR22
1600 / 400 / 867
47.6 kg

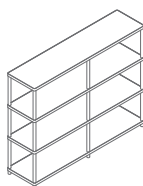

SIR23
1600 / 400 / 1264
63.9 kg

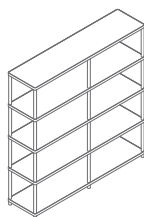

SIR24
1600 / 400 / 1160
80.6 kg

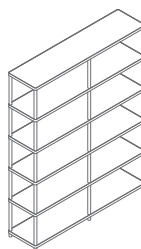

SIR25
1600 / 400 / 2058
96.9 kg

* dimensions expressed in millimeters: width x depth x height

Armchair, sofa

Fabric Medley - second price group



Technical data:

Material polyester 100%

Fabric weight 510 g/lm (16.45 oz./lin.yd.)

Abrasion resistance rubs BS EN ISO 12947-2, 75,000 cykli Martindale

Pilling resistance scale 1-5, max. 5, EN ISO 12945-2 (4)

Colour fastness to light scale 1-8, max. 8, EN ISO 105-B02 (5-7)

Colour fastness to rubbing scale 1-5, max. 5, EN ISO 105x12 (wet/dry (4-5/4-5))

Acoustic test sound absorption ISO 354

Flammability BS EN 1021-1 (cigarette)
BS 476 Part 7, Class 2
Class Uno UNI 9174 - UNI 8457
CA TB 117-2013
ASTM E 84 Class I

Fabric Atlantic * - second price group



Technical data:

Material polyester 100%

Fabric weight 530 g/lm (17.09 oz./lin.yd.)

Abrasion resistance rubs BS EN ISO 12947-2, 110,000 Martindale cycles

Pilling resistance scale 1-5, max. 5, EN ISO 12945-2 (4-5)

Colour fastness to light scale 1-8, max. 8, EN ISO 105-B02 (5-7)

Colour fastness to rubbing scale 1-5, max. 5, EN ISO 105x12 (wet/dry)

Flammability CA TB 117-2013
ASTM E 84 Class I
BS EN 1021-2 (match)
BS EN 1021-1 (cigarette)

Fabric Vita - second price group



Technical data:

Material Surface: 98,5% PVC, 1,5% PU
Substrate: 50% poliester, 50% Cotton

Fabric weight 850g/m2 ± 10% (1190G/lin. m ± 10%)

Abrasion resistance rubs BS EN ISO 5470-2, 100,000 Martindale cycles

Colour fastness to light 6 (ISO 105 - B02)

Colour fastness to rubbing wet: 4, dry: 4 (ISO 105 - X12)

Flammability BS EN 1021 - (cigarette)
BS EN 1021 - 2 (match)
BS 5852 - (Ignition Source 5)
BS 7176 - (Medium Hazard)

Flexes BS EN ISO 7854 - Method B, 400.000 Flexing cycles

Anti-microblal / Anti-fungal AATCC 147

* There is a possibility of ordering the product in full colour spectrum of Atlantic range, as per Gabriel's pattern book, within 8 weeks

Fabric Charles - second price group



Technical data:

Material 100% polyester
Fabric weight 433g/m2
Abrasion resistance rubs 90,000 Martindale cycles (EN ISO 12947-2)
Pilling resistance EN ISO 12945-2, 5
Light fastness EN ISO 105-B02, 5
Rubbing fastness dry: 4-5, wet: 4-5, EN ISO 105x12
Flammability EN 1021, 1

Fabric Mica - second price group

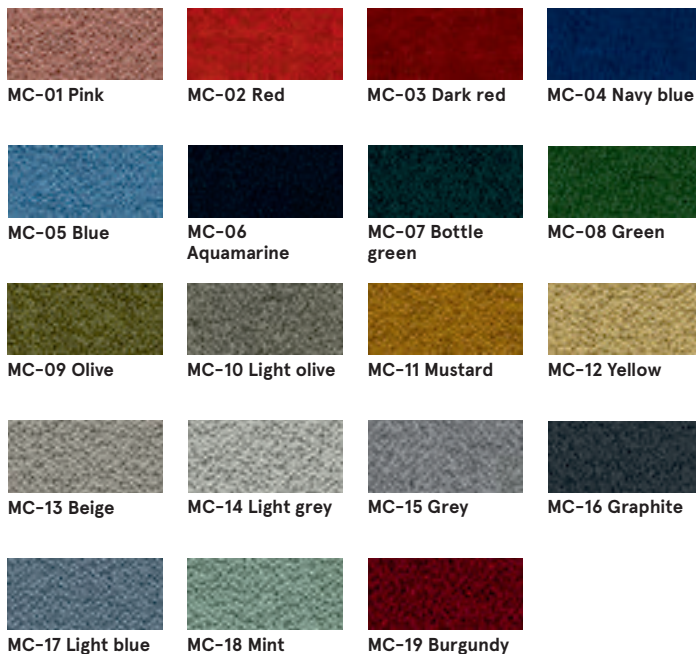

Technical data:

Material post-consumer recycled polyester 97%, polyester 3%
Fabric weight 305 g/lm
Abrasion resistance rubs 60,000 rubs martindale (EN ISO 12947-2)
Pilling resistance scale 1-5, max. 5 - EN ISO 12945-2, 4-5
Light fastness scale 1-8, max. 8 - EN ISO 105-B02, 5-8
Rubbing fastness dry: 4-5, wet: 4-5, scale 1-5, max. 5 - EN ISO 105x12
Flammability CA TB 117-2013
 ASTM E 84 Class I
 BS EN 1021-1 Cigarette
 BS EN 1021-2 Match
 BS 476 Part 7 class I

Fabric Go Check - second price group

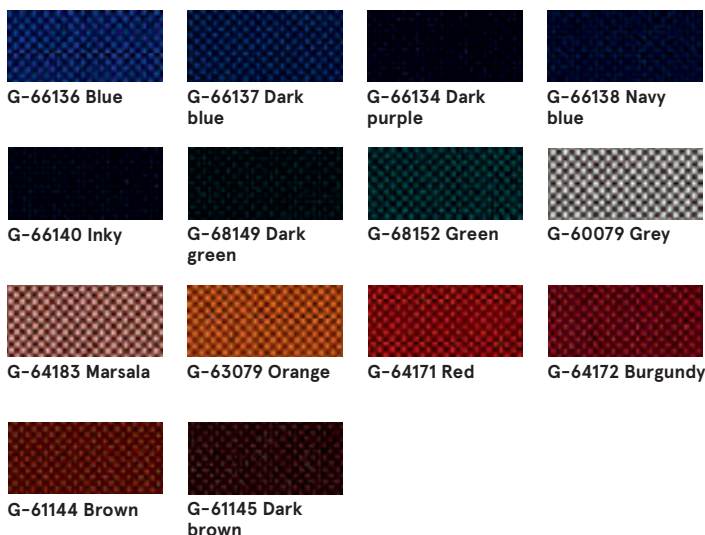

Technical data:

Material 100% Trevira CS
Fabric weight 435g/lm
Abrasion resistance rubs 80,000 rubs martindale (EN ISO 12947-2)
Pilling resistance scale 1-5, max. 5 - EN ISO 12945-2, 5
Light fastness scale 1-8, max. 8 - EN ISO 105-B02, 5-8
Rubbing fastness dry: 4-5, wet: 4-5, scale 1-5, max. 5 - EN ISO 105x12
Flammability BS EN 1021 1&2 Cigarette and Match
 BS EN 1021-1 Cigarette
 BS 5852 Crib 5
 BS 7176 Medium hazard
 DIN 4102 - B1
 NFP 92-503/504/505 M1
 ÖNORM A3800-B1-B3825-Q1 UK
 Class Uno UNI 9175 Class 1 I EMME
 FAR/JAR 25.853 (a) (i) (ii)
 CA TB 117-2013
 DIN EN 13501-1 B-s1,d0
 AM 18 - NF D 60-013-(only for fabric)

Fabric Xtreme - third price group



Technical data:

Material 100% Trevira Clame (CS)
 100% Recykling (YS)
 Flame Retardant polyester.
 Non metallic dyestuffs.
Fabric weight 310 g/m2 ±5% (435g/lin.m ±5%)
Abrasion resistance rubs 60,000 Martindale cycles (CS)
 100,000 Martindale cycles (YS)
Colour fastness to light 6 (ISO 105 - B02)
Colour fastness to rubbing wet: 4, dry: 4 (ISO 105 - X12)
Flammability EN 1021 - 1 (cigarette),
 EN 1021 - 2 (match)
 BS 7176 Low Hazard,
 NF P92-507 M1, DIN 4102 B1,
 UNI 9175 Class 1 IM, UNI 8456,
 UNI 9174 & UNI 9177 Classe Uno,
 ÖNORM B 3825 & A 3800-1
 NF D 60-013

Fabric Synergy - third price group

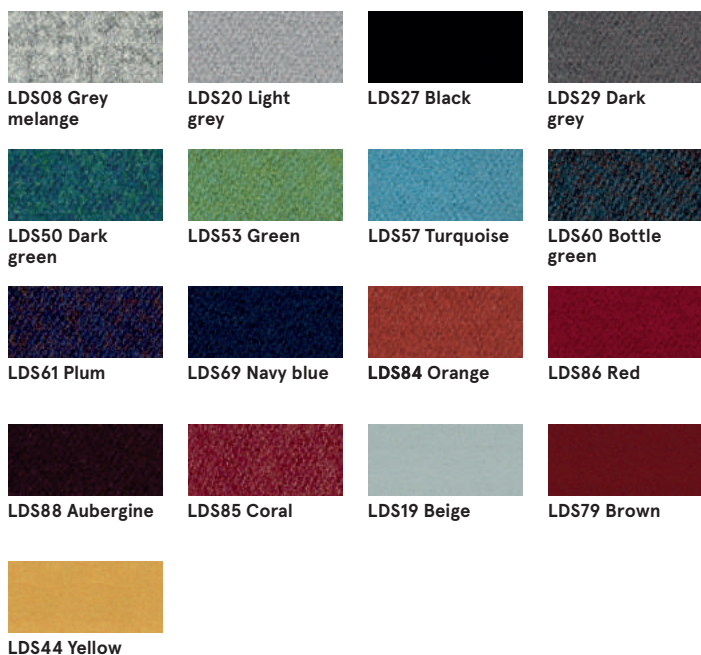

Technical data:

Material 95% Virgin Wool, 5% Poliamid
Fabric weight 400g/m2 ±5% (560 g/lin.m ±5%)
Abrasion resistance rubs Independently certified
 ≥100,000 Martindale cycles
Colour fastness to light 5 (ISO 105 - B02)
Colour fastness to rubbing ISO 105 - X12 - wet: 4, dry: 4
Flammability EN 1021 - 1 (cigarette),
 EN 1021 - 2 (match),
 BS 7176 Low Hazard,
 UNI 9175 Classe 1 IM,
 ÖNORM B 3825 & A 3800-1

Fabric Silvertex – third price group

There is a possibility of ordering the product in full colour spectrum of Silvertex range, as per Spradling’s pattern book, within 15 working days.

Technical data:

Material	Topcoat: 100% Vinyl Backing: 100% Polyesterr Hi-Loft™
Fabric weight	685 gr/m2
Abrasion resistance	>300,000 cycles Martindale
UV-resistance	>= 7 (1000 hours, blue wool scale)
Cold Crack resistance	-23°C
Flame retardancy	NF P 92-503 / M2 EN 1021, Part 1&2 DIN 4102 B2 ÖNORM B 3825, Gruppe I – Schwerbrennbares Verhalten ÖNORM A 3800, Teil I, Qualmbildungsklasse QI – schwachqualmend IMO Res. MSC.307 (88) (2010 FTP Code) Annex I Part 8 (MED) Marine Equipment Directive in its current valid version UNI 9175 (1987) / UNI 9175/FAI (1994) Classe I.IM (uno I EMME) UNE 23.727-90 IR /M2 EN 71-2: 2006+AI: 2007 Safety of Toys – Part 2: Flammability ECE R 118 (replaces Directive 95/28/EC) FMVSS 302 FAR 25/853
Antimicrobial	Antifungal Protection, Antibacterial Protection, Antimycotic Protection

Fabric Atlas – fourth price group



Technical data:

Material	90% new wool, 10% nylon
Fabric weight	286g/m2, 400g/lm
Abrasion resistance rubs	100,000 cyklí Martindale, EN ISO 12947
Colour fastness to light	ISO 105 B02: 6-7
Colour fastness to rubbing	ISO 105-X12:2001, (wet/dry) 4-5/4-5
Flammability	BS EN 1021-2 Match, BS EN 1021-1 Cigarette, BS 5 5852 Crib 5, BS 5852 ignition source 3, BS 5852 Part 1, NF D 60 013, UNI 9175 1M, US Cal. Bull. 117-2013

Fabric Field2 – fourth price group



Technical data:

Material	100% Trevira CS
Fabric weight	321g/m2, 450g/lm
Abrasion resistance rubs	100,000 cyklí Martindale, EN ISO 12947
Colour fastness to light	ISO 105 B02: 5-7
Flammability	BS EN 1021-2 Match, BS EN 1021-1 Cigarette, BS 5 5852 Crib 5, DIN 4102 B1 FAR 25.853, UNI 9177 classe 1, US Cal. Bull. 117-2013

Leather - fourth price group



Technical data:

Material	Leather type - corrected grain leather Type of finishing - pigmented leather
Abrasion resistance rubs	Dry: 500 cycles - min. 4 grey scale Wet: 250 cycles - min. 4 grey scale UNI EN ISO 11640
Colour fastness to light	Light fastness: min. 4 grey scale, UNI ISO 105-802
Flammability	No ignition UNI EN 1021-1-2006 BS EN 1021-1-2006

Base - metal



Bookcase - top and base

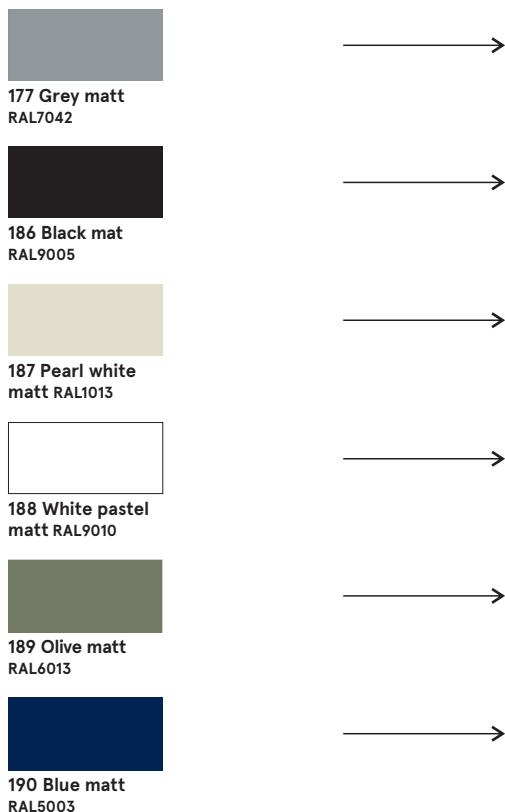

Frame

